

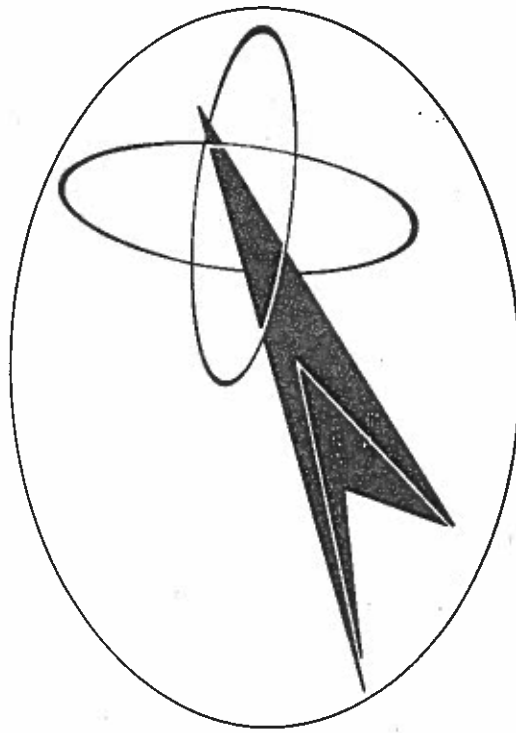

HORIZON AVIATION

2410 Rickenbacker Way • Auburn, CA. 95603

AUTOCONTROL III B



OPERATING INSTRUCTIONS

TABLE OF CONTENTS

SECTION I	Page
Description	1
Console	1
Nav/Approach Coupler	2
Coupler Radio Selector Switch	4
Gyros	5
Servo	6
Amplifier	6
SECTION II	
Operation	7
Preflight Ground Check	7
Preselect	8
Coupler	8
Engaging In Flight	9
Use of Heading Hold and Preselect	9
Use of Bank Command Function	9
Override	9
Malfuction	9
	10
SECTION III	
Operation of Omni/Loc Radio Coupler	11
Intercepting VOR Radials	12/13
VOR Navigation	14/15
Omni Approach	16/17
ILS Approach (Radar Surveillance Directed)	18/19
ILS Approach (Standard Front Course Approach)	20/21
ILS Back Course Approach (Radar Surveillance Directed)	22/23
SECTION IV	
Check List	24

Additional copies of this manual, Part No. 761 600, may be obtained from your Piper Dealer.

Published by
PUBLICATIONS DEPARTMENT
Piper Aircraft Corporation
761 600
Issued: June 1974

PIPER AUTOCONTROL III B

INTRODUCTION

The Piper AutoControl III B is a lightweight automatic flight system using an advanced design and offering maximum utility and reliability. It operates in the 5,000 cycle audio frequency range.

The AutoControl III B offers a new concept in flight control. The conventional servo "follow-up" is not employed. It has been replaced by a solid state analytical computer. The Roll responses are controlled by the amplifier, with the aerodynamics of the aircraft supplying the follow-up information, resulting in smooth attitude control. This system is not equipped to control the pitch axis of the aircraft.

NOTE

ALTHOUGH THE PIPER AUTOCONTROL III B WILL GIVE LONG AND TROUBLE FREE SERVICE, IT MAY IN TIME REQUIRE ADJUSTMENT. AS WITH ANY HIGH QUALITY ELECTRONIC EQUIPMENT, THE PIPER AUTOCONTROL III B SHOULD BE SERVICED, WHEN REQUIRED, BY PROPERLY TRAINED PERSONNEL. IT IS RECOMMENDED THAT THE OWNER SHOULD CONSULT THE FACTORY APPROVED AUTOPILOT SERVICE CENTER LISTING AND MAKE CERTAIN A FACTORY REGISTERED PIPER AUTOPILOT SPECIALIST PERFORMS THE ACTUAL MAINTENANCE ON THE UNIT. THE LIST IS AVAILABLE AT YOUR PIPER DISTRIBUTOR, OR WRITE FOR YOUR COPY TO PIPER AIRCRAFT CORPORATION, LOCK HAVEN, PENNSYLVANIA 17745, U. S. A.

PIPER AUTOCONTROL III B

SECTION I

DESCRIPTION

CONSOLE

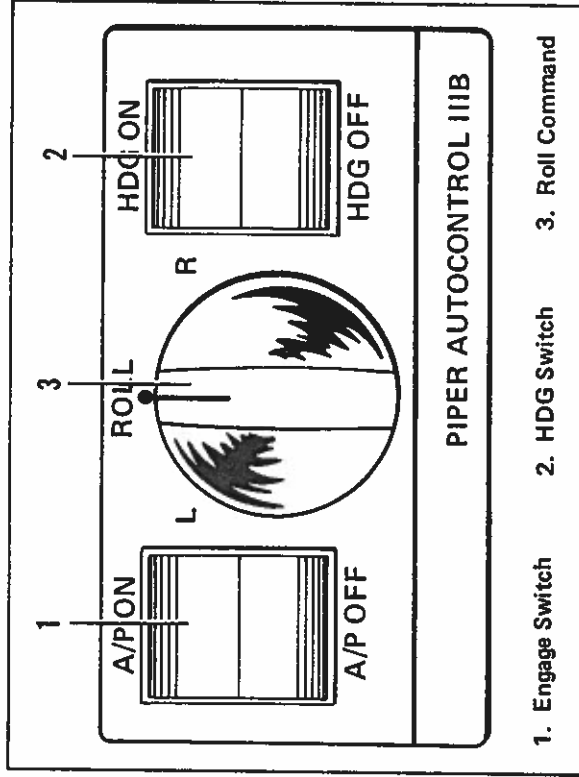

FIGURE 1

Within the AutoControl Console will be found all control functions with the exception of the Course Selector (C/S incorporated in the Directional Gyro). If the system employs radio coupling, the pilot selects the mode of operation at the coupler. For night operation the console and coupler are indirectly illuminated, with intensity being controlled in conjunction with the panel lights.

PIPER AUTOCONTROL III B

NAV/APPROACH COUPLER

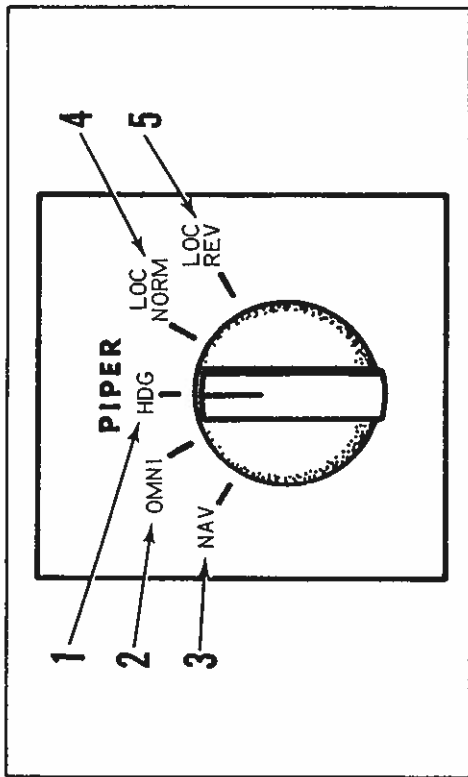

FIGURE 2

The Piper OMNI/LOC COUPLER used in conjunction with the AutoControl III B is a complete analog computer system. The following is a description of the five "MODES" as shown in Figure 2 above.

1. HDG (HEADING) MODE — When selected to the HDG Mode, the AutoControl III B operates as a standard Autopilot without coupling, see Page 9 — HEADING HOLD AND PRESELECT.
2. OMNI MODE — When selected to the OMNI Mode, the coupler will automatically intercept, capture, track, and make crosswind corrections up to 15° on any desired VOR radial the pilot selects as explained in the operations section of this manual, Pages 16 and 17.
3. NAV (NAVIGATION) MODE — When selected to the NAV Mode, the coupler will automatically intercept, capture, track and correct for crosswind on any desired VOR radial the pilot selects. This position is used to cancel any short term deviations of the transmitted VOR signal by FAA stations, resulting in a smooth and positive flight path to or from any VOR facility. See operations section of this manual, — INTERCEPTING VOR RADIALS, Pages 12 and 13 and VOR NAVIGATION, Pages 14 and 15.

PIPER AUTOCONTROL III B

NOTE

ALTHOUGH THE OMNI AND NAV MODES CAN BOTH BE USED FOR VOR NAVIGATION, IT IS RECOMMENDED PROCEDURE TO USE ONLY THE OMNI MODE FOR VOR APPROACH WORK. (See Pages 12 thru 17).

Because of ILS radio transmission characteristics, it is necessary to correct away from the course deviation indicator (vertical needle) during certain phases of an ILS approach. It is for this reason that the coupler provides modes 4 and 5.

4. LOC NORM (Localizer Normal) — When selected to the LOC NORM Mode, the coupler will automatically intercept, capture, track and correct for crosswind conditions up to 15° during ILS approach work. Also, this mode automatically adjusts for the increased sensitivity that accompanies the ILS system. The use of this function is explained in the operations section of this manual, Pages 18 thru 21.

5. LOC REV (Localizer Reverse) — When selected to the LOC REV Mode, the coupler will automatically intercept, capture, track and correct for crosswind conditions during ILS approach work, when it is necessary to correct AWAY from the course deviation indicator (vertical needle). Also, this mode automatically adjusts for the increased sensitivity that accompanies the ILS system. The use of this function is explained in the operations section of this manual, Pages 22 and 23.

IMPORTANT NOTE

The information supplied the coupler from the omni converter is magnetic. The Directional Gyro supplies heading information to the coupler, also magnetic. IT IS MOST IMPORTANT THAT THE DIRECTIONAL GYRO BE ACCURATELY SET WITH THE COMPASS AND THAT THE COMPASS BE

PIPER AUTOCONTROL III B

ACCURATE. For example: Should the Directional Gyro be set to 90° (either because of misreading the compass or because of compass error) when actually it should have been set to 80°, this would result in the coupler having automatic crosswind correction of 25° on one side and only 5° on the other side, instead of 15° and 15° designed into it to cope with crosswind conditions. This would result, eventually, in noting that the Omni Indicator calls for the aircraft to be directed to one side or the other and it would appear that the coupler is not capable of correcting. Should a condition exist which requires more correction to one side or the other than the 15° crosswind correction angle built into the coupler, this can be had by adjusting the Course Selector a few degrees into the crosswind to center the Omni needle.

COUPLER RADIO SELECTOR SWITCH

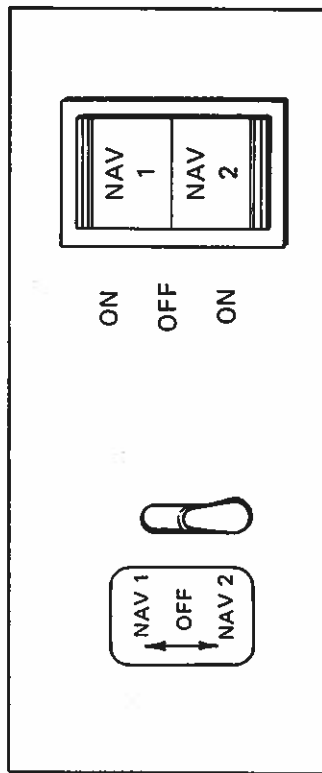

FIGURE 3

This switch connects the coupler to either the #1 or #2 radio. The switch can also be positioned to the center in the event the coupler malfunctions. In the center position both #1 and #2 radios are disconnected from the coupler.

PIPER AUTOCONTROL III B

GYROS

The instruments employed in the Piper AutoControl III B are newly manufactured 3" lightweight gyros. The Attitude Indicator and Directional Gyro are air-driven and supply signals to the amplifier. The Directional Gyro incorporates the heading Preselect feature, hereafter referred to as the Course Selector. The air to these gyros passes through a central filter - periodically, this filter should be changed to increase gyro life.

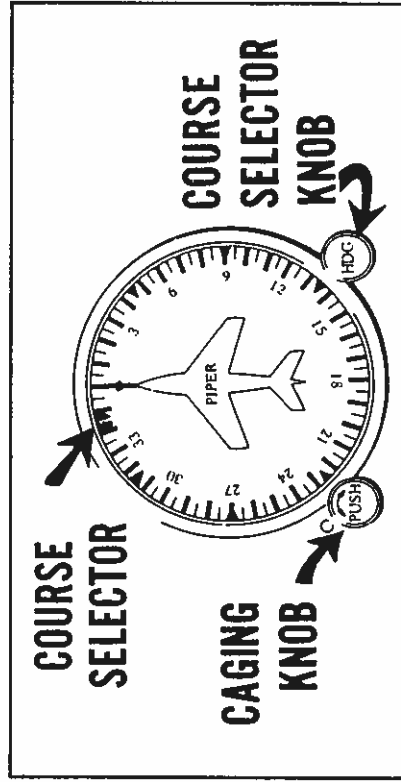

FIGURE 4

The Course Selector Directional Gyro is set to agree with the magnetic compass in the usual manner with the caging knob located in the lower left corner of the instrument. To set the 3" Directional Gyro, the caging knob is pushed in and rotated and the magnetic heading from the magnetic compass is set in the top of the instrument, under the nose of the airplane pictured on the instrument. (See Important Note on Page 3).

The Course Selector Knob is located at the lower right-hand corner of the instrument and controls the Course Selector as seen in Figure 4. To use this control, the pilot must push in on the Course Selector Knob and by rotating this control knob he can select any course by placing the Course Selector on the desired heading. When the AutoControl III B is engaged, the Course Selector function of this instrument becomes the primary control of the aircraft around the roll axis. When

PIPER AUTOCONTROL III B

the Course Selector agrees with the Heading of the aircraft, the Autopilot will maintain that heading. If the pilot desires to turn to a new heading, he has simply to "dial" the heading using the Course Selector and the aircraft will turn to the new heading.

SERVOS

The electro mechanical servos engage electrically and are easily overridden. They cause no friction in the aircraft control system when disengaged. They disengage automatically if the electrical system fails.

AMPLIFIER

The amplifier is of solid state design. The low current drain amplifier incorporates analytical computer circuitry which results in extremely smooth control of the aircraft.

PIPER AUTOCONTROL III B

SECTION II

OPERATION

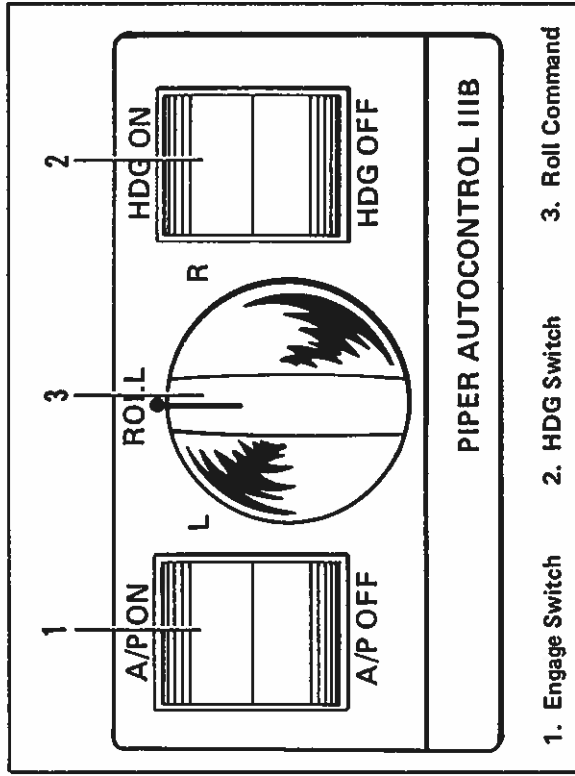

FIGURE 5

PREFLIGHT GROUND CHECK

To ground check the AutoControl III B, the gyros must be erected:

- Heading switch (#2) in the OFF position.
- The Roll Command Knob (#3) centered.
- Engage ON/OFF switch (#1).
- Move the Bank Command Knob (#3) right and left and observe that the control wheel moves in the same direction.

PIPER AUTOCONTROL III B

- e. Position the Roll Command Knob to stop the control wheel from turning to either side. With no feedback from the servo, the control wheel can be expected to turn against its stop while the Roll Command Knob is off center.

PRESELECT

- a. Set Directional Gyro to correspond with the magnetic compass.
- b. Center the Course Selector over this heading employing the right hand knob of the Directional Gyro.
- c. If coupler equipped, the Coupler Knob should be in Heading (Hdg) position.
- d. Heading switch (#2) must be engaged.
- e. Set the Course Selector for a heading change to the right - control wheel should turn right. Make same check to the left. As in the case of the Roll Command, the control wheel will turn against its aileron stop on each side.
- f. Center the Course Selector until the control wheel ceases to turn to either side.

COUPLER

- a. Tune in any available Omni station on the top receiver.
- b. Center Omni needle with a "TO" flag by using the OBS.
- c. Cage and set the Directional Gyro to coincide with the selected Omni bearing.
- d. Set Course Selector to coincide with the selected Omni bearing.
- e. Place Coupler Selector Switch to the Omni - 1 position.
- f. Place Coupler in the Omni Mode.
- g. Turn Omni Bearing Selector to swing Omni needle for a full deflection to the RIGHT, control wheel should follow.
- h. Turn Omni Bearing Selector to swing Omni needle for a full deflection to the LEFT, control wheel should follow.
- i. Disengage AutoControl, this completes the ground check.

PIPER AUTOCONTROL III B

ENGAGING IN FLIGHT

BEFORE ENGAGING THE AUTOCONTROL III B, MAKE CERTAIN THE AIRCRAFT IS TRIMMED FOR HANDS-OFF LEVEL FLIGHT WITH THE BALL IN THE CENTER.

USE OF HEADING HOLD AND PRESELECT

- a. If the system incorporated Radio Coupling, Coupler Selector Knob should be set to the Heading (Hdg) Mode.
- b. Set the Course Selector of the Directional Gyro to align with the Heading.
- c. Engage ON/OFF switch (#1).
- d. Center the Bank Command Knob (#3). Engage Heading switch (#2).

Heading changes are now made by setting the Course Selector of the Directional Gyro to the desired heading. It should be noted that with the Heading switch engaged, the Roll Command Knob (#3) is inoperative.

USE OF ROLL COMMAND FUNCTION

In order to employ this function, the Heading switch (#2) must be OFF. Banks of approximately 30 degrees can be had for a full bank command.

OVERRIDE

Approximately nine to fifteen pounds of force on the control wheel should override the AutoControl III B when engaged. Override settings may vary with different models of aircraft. The AutoControl III B roll servos have the new carbon/copper clutch assemblies which

are not subject to excessive wear during prolonged or frequent use of the override feature. The override should be checked prior to each flight. To check override:

- a. Place Radio Coupler in "Heading" mode and place A/P ON/OFF switch in the "ON" position to engage roll section.
- b. While D.G. Course Selector is set for a left turn, grasp control wheel and override the servo to the right.
- c. Repeat Step b in opposite direction for a right turn.

MALFUNCTION

In the event of a malfunction, disengage the ON/OFF switch (#1).

SECTION III

OPERATION OF OMNI/LOC RADIO COUPLER

- Intercepting VOR Radials
- VOR Navigation
- Omni Approach
- ILS Approach (Radar Surveillance Directed)
- ILS Approach (Standard Front Course Approach)
- ILS Back Course Approach (Radar Surveillance Directed)

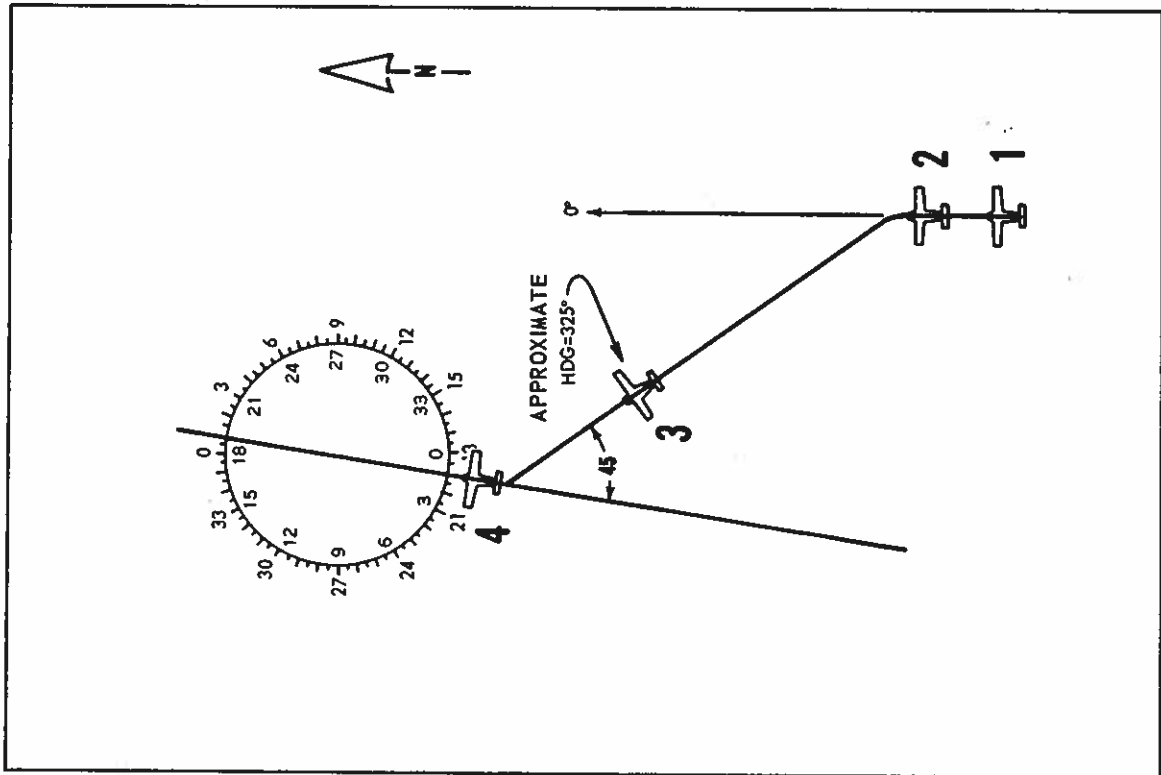

INTERCEPTING VOR RADIAL

INTERCEPTING VOR RADIALS

1. While flying with AutoControl III B engaged and operating in the HEADING MODE of the coupler, tune in an OMNI station and set the OBS to the desired radial (standard OMNI procedure).

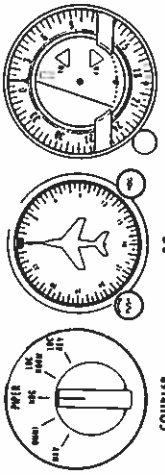

2. With OMNI setup complete, set the identical course (from the OBS) in the DIRECTIONAL GYRO by using the COURSE SELECTOR. Switch the COUPLER from the HEADING MODE to the OMNI or NAV MODE.

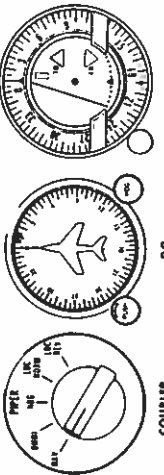

3. The aircraft will turn to intercept the desired radial, at an angle not exceeding 45°, and the coupler will automatically compute closure rate and position.

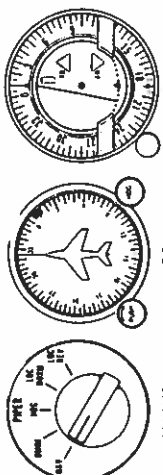

4. The coupler will roll the aircraft onto the selected radial at the proper time, and will establish the crosswind corrected heading of the aircraft immediately upon rollout.

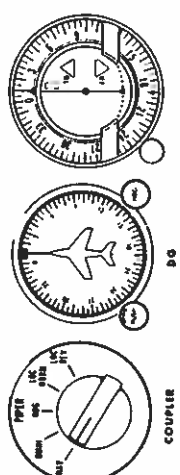

PIPER AUTOCONTROL III B

It is important to note that the Course Selector will sometimes line up off course when flying on a radial in a crosswind. This displays the wind correction angle or "crab angle".

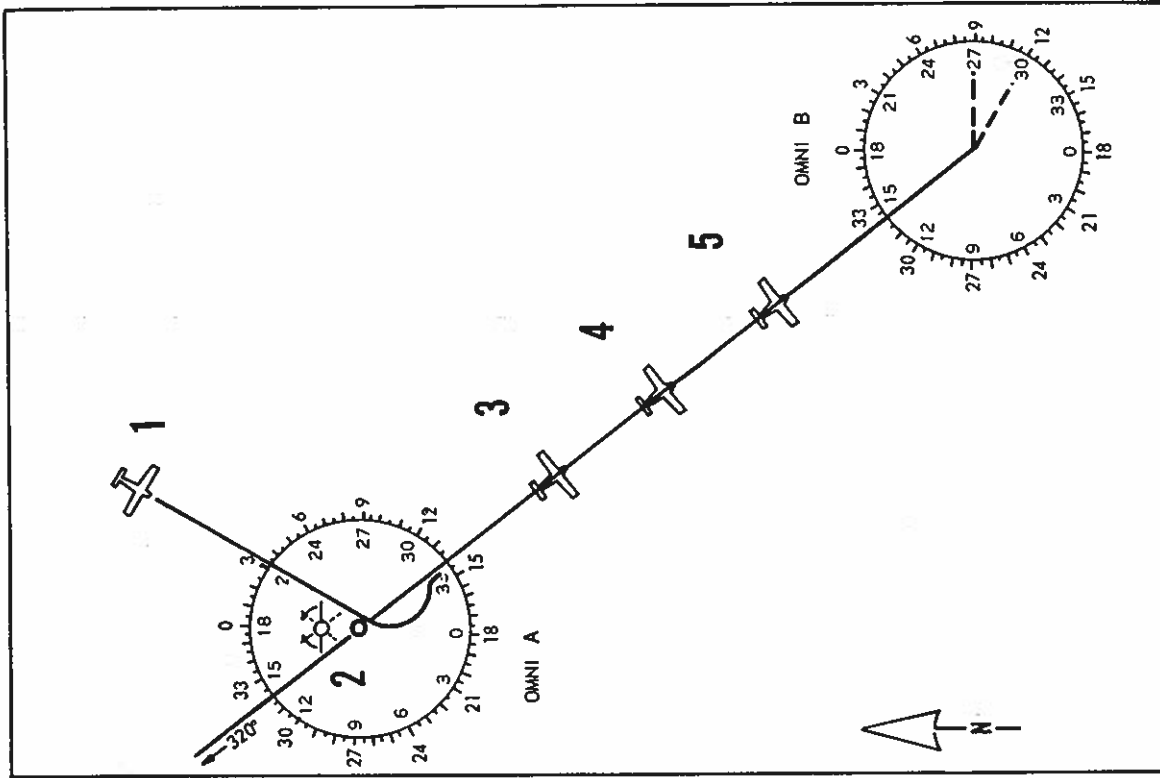

VOR NAVIGATION

VOR NAVIGATION

1. The aircraft is inbound and coupled to the 032 degree radial of OMNI A (as per Page 13 — INTERCEPTING VOR RADIAL).

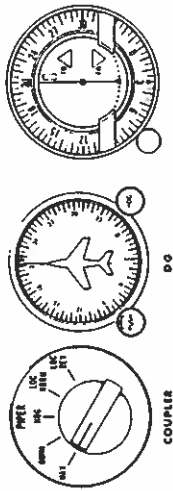

2. When flying through the "Cone of Confusion" directly over the OMNI station, the aircraft will gently roll to the right and to the left indicating station passage. At this point the pilot will select the desired outbound radial, 140 degrees in the OBS and also set the Course Selector to 140 degrees.

NOTE

It is not necessary to change coupling modes and the coupler should be left in the NAV position.

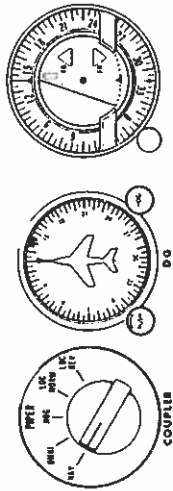

3. The aircraft will automatically turn left to intercept the 140 degree radial of OMNI A, and will compensate for any crosswind or station overshoot.

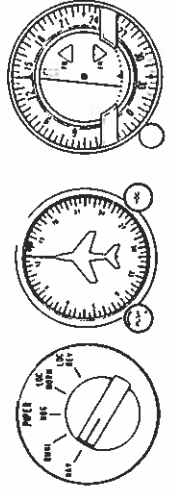

4. When normal OMNI sensitivity decreases on station A, the pilot should tune in station B to obtain normal sensitivity due to distance from the stations (standard OMNI procedure). When Omni sensitivity dictates changing from station A to station B, the operator can pre-set his other VOR receiver to the proper frequency and inbound course to station B and simply actuate his coupler radio selector switch to the Omni 2 position for ease of operation. (See Page 4.)

NOTE

If it is desired to use the same VOR receiver for navigating to station B, the Autopilot coupler should be placed in the HDG mode while the VOR receiver is being returned to the station B frequency.

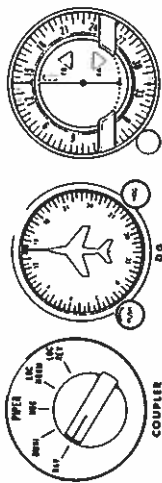

5. The coupling procedure is repeated as described above from station to station as the aircraft progresses along its route.

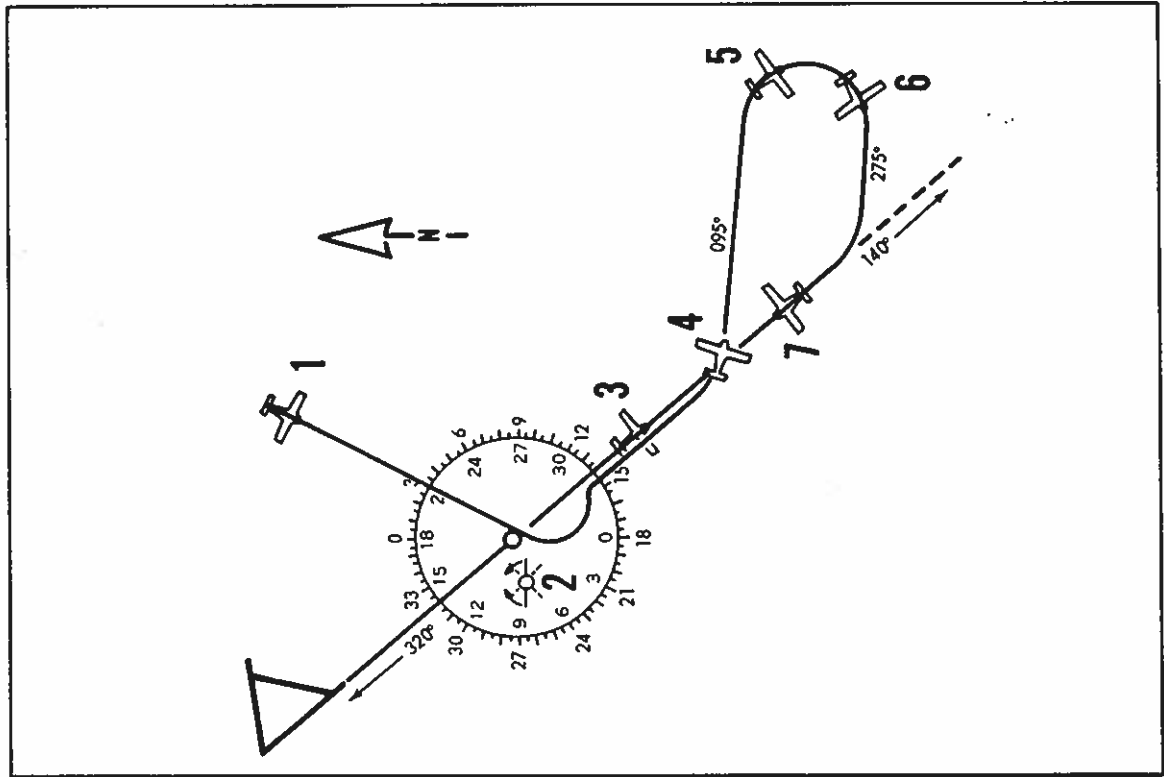

OMNI APPROACH

OMNI APPROACH

1. The aircraft is inbound on the 032 degree radial with the compass, Directional Gyro, Course Selector and Omni indicator reading 212 degrees. (No wind condition). The coupler will track the radial leaving the pilot free to PLAN AHEAD for his OMNI approach. The coupler would be in the NAV position at this time since the approach has not yet begun.
2. After the aircraft is rolling to the right and left indicating station passage, the pilot will select the 140 degree radial in the OBS, set the Course Selector to 140 degrees in the Directional Gyro and move the coupler mode to OMNI position.

NOTE

It is recommended that the Omni position of the Coupler be used for approach work.

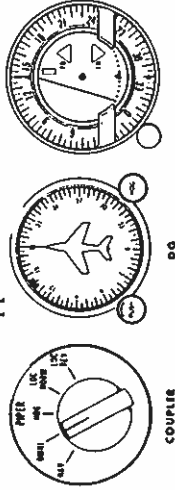

3. The coupler will automatically intercept the 140 degree radial outbound and correct for winds and overshoot of the station and establish the aircraft on the outbound course.

4. At the time for procedure turn, the pilot will select the HDG. Mode of the coupler and rotate the Course Selector to the left to agree with the published outbound heading of the procedure turn, 095 degrees.

NOTE

The pilot must compensate for winds while in the HDG. Mode of the coupler.

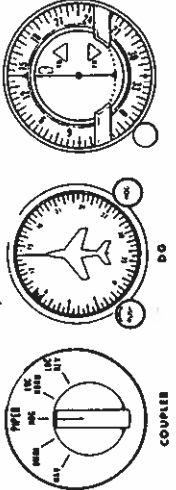

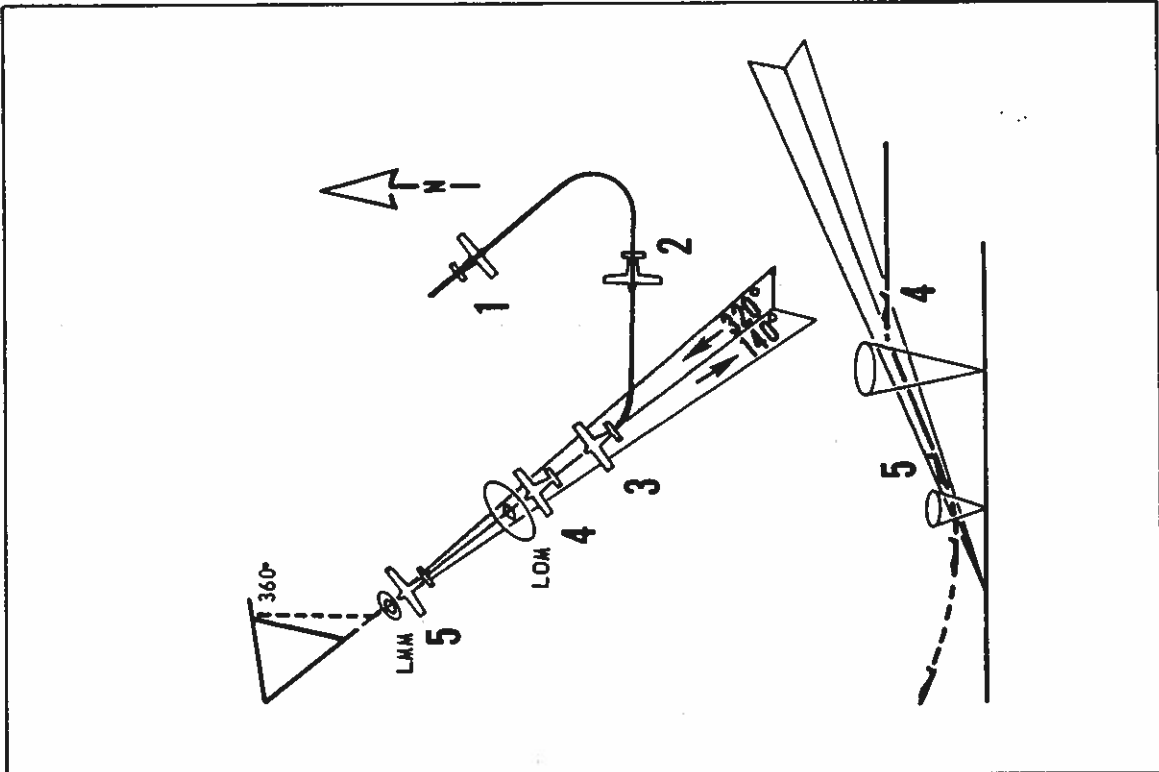

ILS FRONT COURSE APPROACH

ILS APPROACH (Radar Surveillance Directed)

It must be realized by the operator that the Instrument Landing and Approach System (ILS) is four times as narrow and four times as sensitive as the VOR system of navigation. Therefore, to use the coupler on a localizer, the speed of the aircraft must be held to approach speeds in order for the coupler to perform as required. The coupler will not make up for lack of knowledge and understanding of the ILS system on the part of the operator. However, the coupler will function with a high degree of safety if standard ILS procedures are followed. It must also be understood that while the OBS is not used on ILS approaches (because of the radio transmission principles involved) the Course Selector must be set to the inbound heading of the Localizer to prevent the aircraft from orbiting. The Piper coupler will not orbit when used correctly, as most other systems will.

1. When receiving Airport Surveillance Radar (ASR) vectors to a localizer, the pilot will be given headings to steer by the radar controller. When contacting the controller, make sure he is aware of the intercept angle limitations by stating "THIS WILL BE AN AUTOMATIC APPROACH". This will alert the radar operator that the intercept angle must not be 90 degrees or some large angle, thereby adversely affecting the performance of the coupler. At this point the pilot will have the coupler in the HDG Mode and will use the Course Selector to dial the headings given by the radar controller.

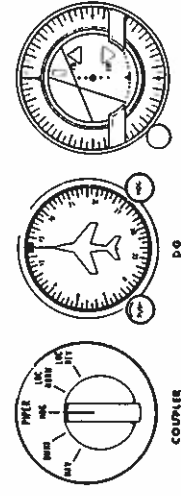

5. At the end of the first leg of the procedure turn (depending on what type of procedure turn the pilot chooses), usually one minute, the pilot will rotate the Course Selector to the right to approximately 20 degrees less than the reciprocal or 255 degrees.

NOTE

It is recommended procedure that the OBS be set to the inbound course 320 degrees while flying the outbound leg of the procedure turn.

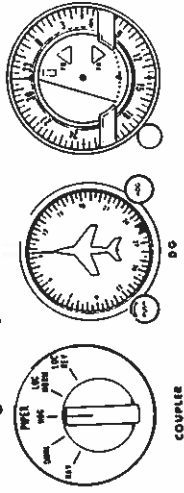

6. With the aircraft turning right, the pilot now sets the Course Selector further right to the inbound radial of 320 degrees to match his OBS. After the Course Selector and OBS are both set to 320 degrees, the coupler is switched to the OMNI Mode.*

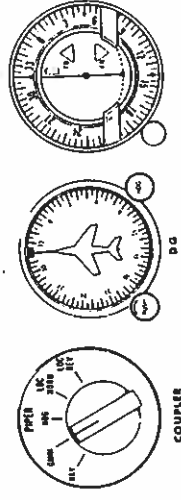

7. The coupler will now intercept the 140 degree radial inbound, and after station passage will continue to track the 320 degree radial outbound; no further adjustments are necessary except to set up a rate of descent to the runway.

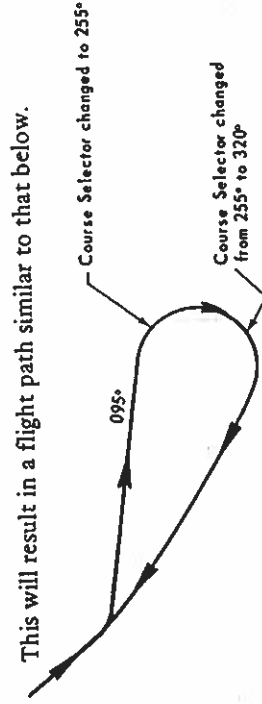

This will result in a flight path similar to that below.

2. When the radar controller has the aircraft in position for the localizer intercept, the pilot will select the INBOUND HEADING OF THE LOCALIZER in the Directional Gyro by placing the COURSE SELECTOR to that heading. Then the pilot will select the LOC NORM MODE of the coupler.

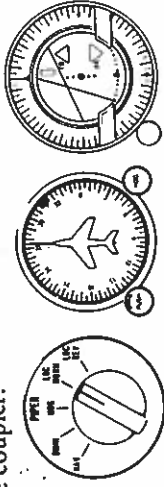

3. The coupler will intercept the localizer and correct for any crosswind up to 15°.

4. The pilot will adjust the rate of descent when over the Outer Marker as in any ILS approach. It must be noted that the coupler is only controlling the heading of the aircraft and not the rate of descent.



5. When over the Middle Marker, the pilot should disengage the Automatic Pilot and take over control of the aircraft manually. With the Autopilot disengaged, the coupler is no longer operating and the Mode on the coupler is of no importance. However, the coupler should be set to the Hdg. Mode in case of a "go-around" and re-engagement of the Autopilot.

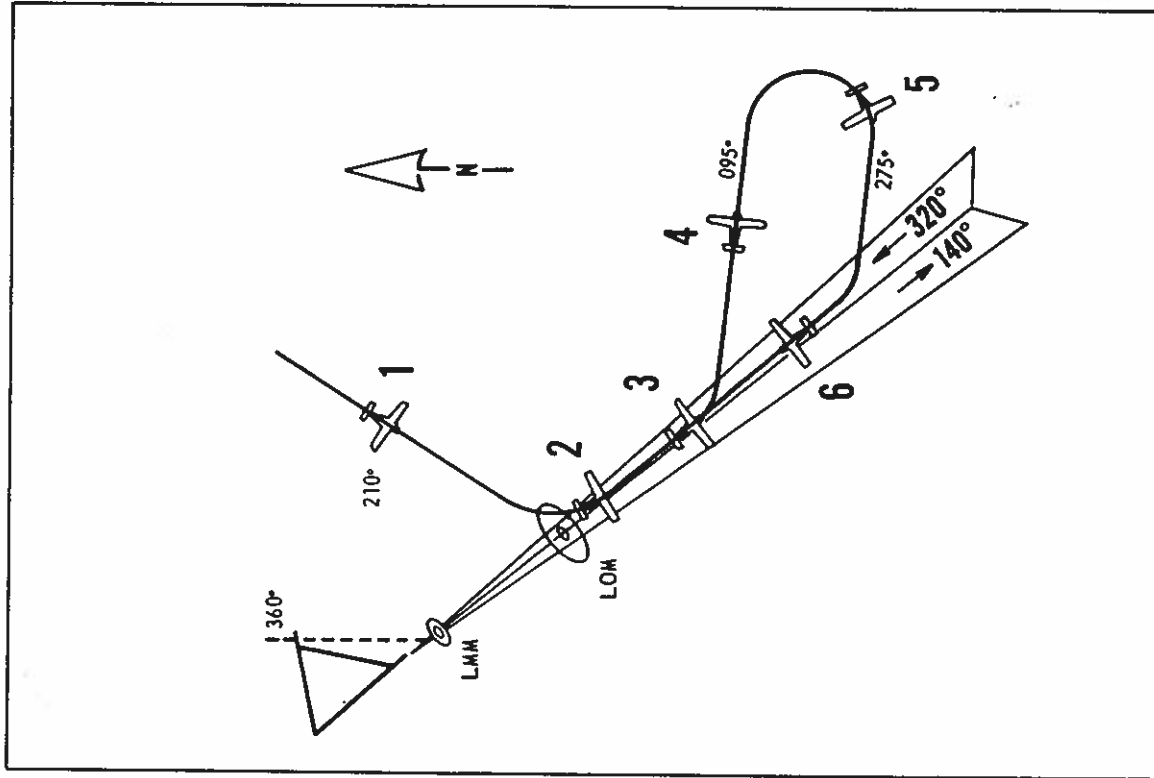

ILS FRONT COURSE APPROACH

ILS APPROACH (Standard Front Course Approach)

1. In this type of ILS approach the aircraft is Homing on the Outer Compass Locator (which is at the Outer Marker) by use of ADF. The coupler will be selected to the HDG MODE and the pilot will be using the COURSE SELECTOR to control the aircraft heading. The ILS should be tuned in prior to reaching the Outer Marker.

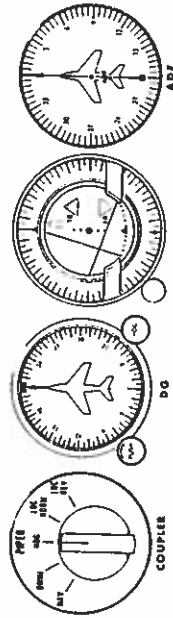

2. Upon intercepting the localizer at Outer Marker, the pilot will set the COURSE SELECTOR to the OUTBOUND HEADING OF THE LOCALIZER, 140 degrees on the DIRECTIONAL GYRO, and will then move the COUPLER to the LOC REV (localizer reverse) MODE. The coupler will track the localizer outbound, (correcting away from the needle) correcting for any crosswind up to 15°.

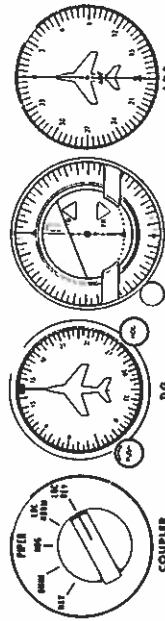

3. At the time of procedure turn, the pilot will select the HDG MODE of the coupler, and rotate the Course Selector to the left to agree with the published outbound heading of the procedure turn, 095 degrees.

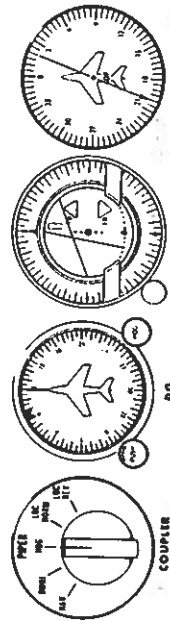

PIPER AUTOCONTROL III B

4. At the end of the first leg of the procedure turn (depending on what type of procedure turn the pilot chooses), usually one minute, the pilot will rotate the **COURSE SELECTOR TO THE RIGHT** to approximately 20 degrees less than the reciprocal or 255 degrees.

5. With the aircraft now turning right, the pilot sets the **COURSE SELECTOR FURTHER RIGHT** to the **INBOUND HEADING OF THE LOCALIZER, 320 degrees**, and then **SWITCHES THE COUPLER TO THE LOC NORM MODE.***

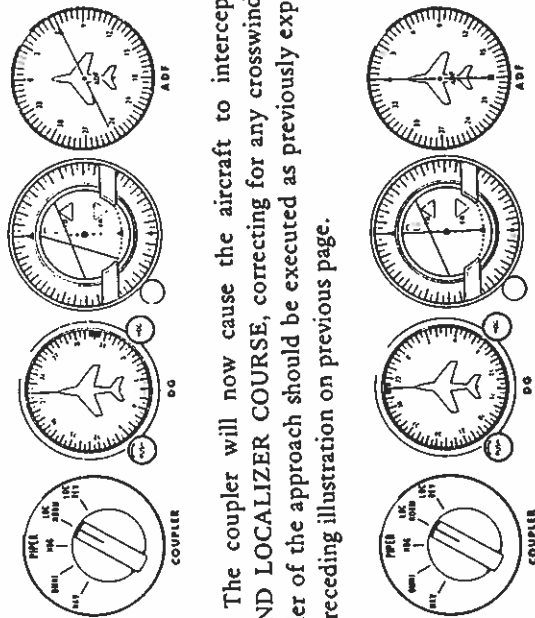

6. The coupler will now cause the aircraft to intercept the **INBOUND LOCALIZER COURSE**, correcting for any crosswind. The remainder of the approach should be executed as previously explained in the preceding illustration on previous page.

This will result in a flight path similar to that below.

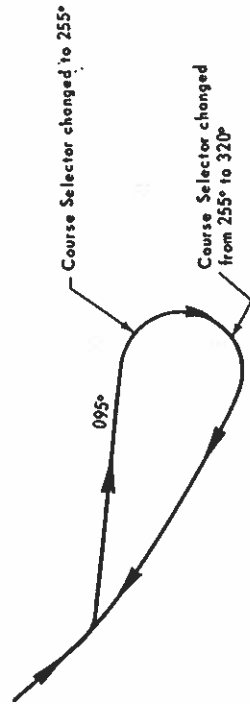

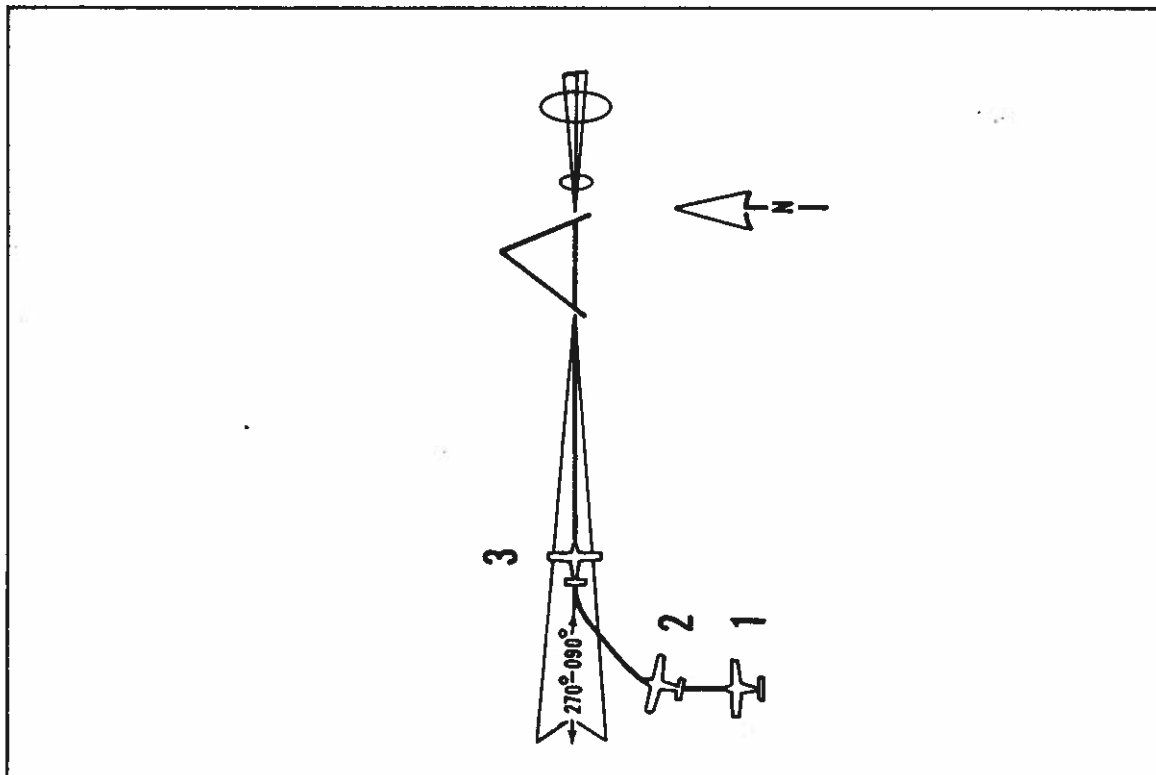

ILS BACK COURSE APPROACH (Radar Surveillance Directed)

At times it may be necessary to make a back course approach on the ILS. There is misunderstanding among many pilots as to when the needle is directional and when the needle is non-directional when using the ILS system. THE NEEDLE DOES NOT REVERSE WHEN FLYING OVER THE FIELD FROM THE BACK COURSE TO THE APPROACH OR FRONT COURSE OR VICE VERSA. THE NEEDLE IS DIRECTIONAL WHEN FLYING INBOUND THE FRONT COURSE (over the markers inbound) AND OUTBOUND THE BACK COURSE. THE NEEDLE IS NON-DIRECTIONAL WHEN FLYING INBOUND ON THE BACK COURSE AND OUTBOUND ON THE FRONT COURSE. To use the coupler when flying the ILS the operator must thoroughly understand the principles of the Instrument Landing and Approach System.

Inbound on the Front Course or Outbound on the Back Course, corrections are toward the needle: Coupler Mode, LOC NORM.

Outbound on the Front Course or Inbound on the Back Course, corrections are away from the needle: Coupler Mode, LOC REV.

1. The aircraft is receiving radar vectors to the Back Course of the localizer with the coupler set to the HDG MODE, and the pilot uses the Course Selector to control the aircraft heading; at this time the pilot also "tunes in" the localizer.

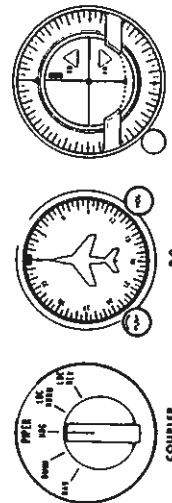

2. At this point the pilot sets the INBOUND HEADING of the BACK COURSE on the Directional Gyro by placing the Course

Selector 090 degrees, and switches to the LOC REV MODE on the coupler. As in any ILS work, the OBS is inactive on ILS.

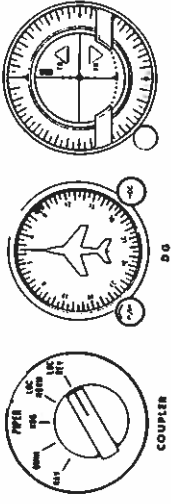

IMPORTANT NOTE

The aircraft **MUST BE FLOWN AT APPROACH SPEED** when using the ILS because of the increased sensitivity that accompanies the system. Also, the aircraft **MUST BE AT LEAST FIVE MILES FROM THE END OF THE RUNWAY** if the coupler is to function properly. (The Autopilot is restricted to standard rate turns; if coupling is attempted too close to the runway, the aircraft will overshoot the localizer because of this fact).

3. The coupler will intercept the Back Course and track inbound on the localizer, correcting for any crosswind that may be present up to 15°.

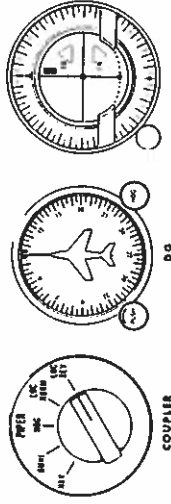

NOTE

Since there is no Glide Path transmitted on the Back Course, the Horizontal needle will be inactive and the "OFF" flag will be visible. Also, the Autopilot should be disengaged (or the HDG MODE should be selected) when approximately one mile from the end of the runway on a Back Course approach, since the Localizer transmitter is now at the approach end of runway.

SECTION IV

CHECK LIST

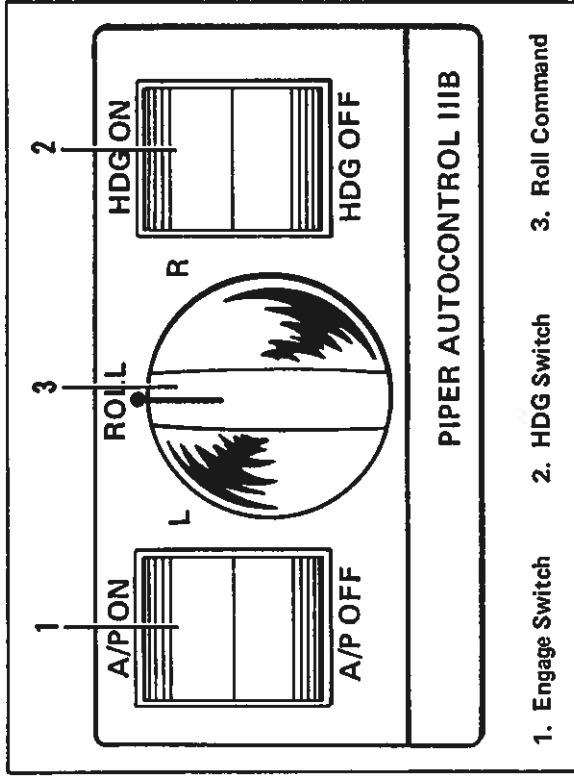

OPERATING INSTRUCTIONS FOR PIPER AUTOCONTROL III B

Engaging Roll Command:

1. All AutoControl switches - OFF, Roll Command centered.
2. Directional Gyro and aircraft compass - aligned.
3. Coupler (if installed) - Heading position.
4. Engage Switch - ON (#1).
5. Turns left and right with up to 30° bank are possible by rotating the Roll Command Knob (#3).

Engaging Heading Preselect:

1. Course Selector (located in Directional Gyro and controlled by "HDG" knob to right of Directional Gyro) aligned with aircraft heading.
2. Heading switch (#2) - engaged.
3. Preselected headings may now be made by rotating course selector in Directional Gyro to any desired heading.

Engaging Radio Coupling:

1. Select an OMNI station that is within range and suitable for navigation on either Nav #1 or Nav #2.
2. Bank command knob (#3) - center.
3. Heading switch (#2) - disengage.
4. Place Nav selector switch in respective Nav position.
5. Omni bearing selector - center.
6. Set Course Selector on Directional Gyro to correspond with setting of O. B. S.
7. Place mode selector in Nav position. (Use OMNI mode for OMNI approach only).
8. Heading preselect button - engage: Autopilot is now coupled to OMNI station.

If interception with a certain radial is necessary, set the desired radial heading on the O. B. S. (not centered), then set the course selector to the same heading. The aircraft will approach desired radial at a 45° angle with full needle deflection on the O. B. S.

