

GMA 345

pilot's guide



Copyright © 2016-2018 Garmin Ltd. or its subsidiaries. All rights reserved.

This manual reflects the operation of GMA 345 units. Some differences in operation may be observed when comparing the information in this manual to earlier or later Mod status levels.

Garmin International, Inc., 1200 East 151st Street, Olathe, Kansas 66062, U.S.A.

Garmin AT, Inc., 2345 Turner Road SE, Salem, OR 97302, U.S.A.

Garmin (Europe) Ltd., Liberty House, Hounsdown Business Park, Southampton, Hampshire SO40 9LR U.K.

Garmin Corporation, No. 68, Zhangshu 2nd Road, Xizhi District, New Taipei City, Taiwan

Web Site Address: **www.garmin.com**

Contact Garmin Product Support at: **www.flygarmin.com**

For warranty information refer to:

<https://fly.garmin.com/fly-garmin/support/warranty-information/>

Except as expressly provided herein, no part of this manual may be reproduced, copied, transmitted, disseminated, downloaded or stored in any storage medium, for any purpose without the express written permission of Garmin. Garmin hereby grants permission to download a single copy of this manual and of any revision to this manual onto a hard drive or other electronic storage medium to be viewed for personal use, provided that such electronic or printed copy of this manual or revision must contain the complete text of this copyright notice and provided further that any unauthorized commercial distribution of this manual or any revision hereto is strictly prohibited.

Garmin® is a registered trademark of Garmin Ltd. or its subsidiaries. These trademarks may not be used without the express permission of Garmin.

©2017 The Bluetooth® word mark and logos are registered trademarks owned by Bluetooth SIG, Inc. and any use of such marks by Garmin is under license. Other trademarks and trade names are those of their respective owners.

AVIATION LIMITED WARRANTY

All Garmin avionics products are warranted to be free from defects in materials or workmanship for the earlier of: 2 years or 800 flight hours from the date of purchase for new TSO remote-mount and TSO panel-mount products; 1 year or 400 flight hours from the date of purchase for new Non-TSO remote-mount* and Non-TSO panel-mount*, portable products and any purchased newly-overhauled products; 6 months or 200 flight hours for factory repaired or newly-overhauled products exchanged through a Garmin Authorized Service Center. Within the applicable period, Garmin will, at its sole option, repair or replace any components that fail in normal use. Such repairs or replacement will be made at no charge to the customer for parts or labor, provided that the customer shall be responsible for any transportation cost. This Limited Warranty does not apply to: (i) cosmetic damage, such as scratches, nicks and dents; (ii) consumable parts, such as batteries, unless product damage has occurred due to a defect in materials or workmanship; (iii) damage caused by accident, abuse, misuse, water, flood, fire, or other acts of nature or external causes; (iv) damage caused by service performed by anyone who is not an authorized service provider of Garmin; or (v) damage to a product that has been modified or altered without the written permission of Garmin. In addition, Garmin reserves the right to refuse warranty claims against products or services that are obtained and/or used in contravention of the laws of any country.

This Limited Warranty also does not apply to, and Garmin is not responsible for, any degradation in the performance of any Garmin navigation product resulting from its use in proximity to any handset or other device that utilizes a terrestrial broadband network operating on frequencies that are close to the frequencies used by any Global Navigation Satellite System (GNSS) such as the Global Positioning Service (GPS). Use of such devices may impair reception of GNSS signals.

TO THE MAXIMUM EXTENT PERMITTED BY APPLICABLE LAW, THE WARRANTIES AND REMEDIES CONTAINED IN THIS LIMITED WARRANTY ARE EXCLUSIVE AND IN LIEU OF, AND GARMIN EXPRESSLY DISCLAIMS, ALL OTHER WARRANTIES AND REMEDIES, WHETHER EXPRESS, IMPLIED, STATUTORY, OR OTHERWISE, INCLUDING WITHOUT LIMITATION ANY IMPLIED WARRANTY OF MERCHANTABILITY OR FITNESS FOR A PARTICULAR PURPOSE, STATUTORY REMEDY OR OTHERWISE. THIS LIMITED WARRANTY GIVES YOU SPECIFIC LEGAL RIGHTS, AND YOU MAY HAVE OTHER LEGAL RIGHTS WHICH VARY FROM STATE TO STATE. IF IMPLIED WARRANTIES CANNOT BE DISCLAIMED, THEN SUCH WARRANTIES ARE LIMITED IN DURATION TO THE DURATION OF THIS LIMITED WARRANTY. SOME STATES DO NOT ALLOW LIMITATIONS ON HOW LONG AN IMPLIED WARRANTY LASTS, SO THE ABOVE LIMITATION MAY NOT APPLY TO YOU.

IN NO EVENT SHALL GARMIN BE LIABLE FOR ANY INCIDENTAL, SPECIAL, INDIRECT OR CONSEQUENTIAL DAMAGES, WHETHER RESULTING FROM THE USE, MISUSE OR INABILITY TO USE THE PRODUCT OR FROM DEFECTS IN THE PRODUCT. SOME STATES DO NOT ALLOW THE EXCLUSION OF INCIDENTAL OR CONSEQUENTIAL DAMAGES, SO THE ABOVE LIMITATIONS MAY NOT APPLY TO YOU.

Garmin retains the exclusive right to repair or replace (with a new or newly-overhauled replacement product) the product or software or offer a full refund of the purchase price at its sole discretion. SUCH REMEDY SHALL BE YOUR SOLE AND EXCLUSIVE REMEDY FOR ANY BREACH OF WARRANTY.

Online auction purchases: Products purchased through online auctions are not eligible for warranty coverage. Online auction confirmations are not accepted for warranty verification. To obtain warranty service, an original or copy of the sales receipt from the original retailer is required. Garmin will not replace missing components from any package purchased through an online auction.

International purchases: A separate warranty may be provided by international distributors for devices purchased outside the U.S., depending on the country. If applicable, this warranty is provided by the local in-country distributor and this distributor provides local service for your device. Distributor warranties are only valid in the area of intended distribution. Devices purchased in the U.S. or Canada must be returned to the Garmin service center in the U.K., the U.S., Canada or Taiwan for service.

To obtain warranty service, contact your local Garmin Authorized Service Center. For assistance in locating a Service Center near you, visit the Garmin Web site at "<http://www.garmin.com>" or contact Garmin Customer Service at 800-800-1020.



CAUTION: *Incorrect aircraft wiring could short the left channel or both channels to ground if a monaural headset is plugged into the stereo jacks. If wired incorrectly, fail-safe operation will not work.*

Transmitter Grant of Equipment Authorization

FCC

Contains FCC ID: QOQWT321



This device complies with Part 15 of the FCC Rules. Operation is subject to the following two conditions: (1) this device may not cause harmful interference, and (2) this device must accept any interference received, including interference that may cause undesired operation.

FCC RF Radiation Exposure Statement:

This equipment complies with FCC radiation exposure limits set forth for an uncontrolled environment. End users must follow the specific operating instructions for satisfying RF exposure compliance. This transmitter meets both portable and mobile limits as demonstrated in the RF Exposure Analysis. This transmitter must not be co-located or operating in conjunction with any other antenna or transmitter except in accordance with FCC multi-transmitter product procedures.

IC

Contains IC: 5123A-BGTWT321

NOTE

This device complies with Innovation, Science and Economic Development Canada license-exempt RSS standard(s). Operation is subject to the following two conditions: (1) this device may not cause interference, and (2) this device must accept any interference, including interference that may cause undesired operation of the device.

Cet appareil est conforme aux normes RSS sans licence du ministère Innovation, Sciences et Développement économique Canada. Son fonctionnement est soumis aux deux conditions suivantes : (1) ce périphérique ne doit pas causer d'interférences et (2) doit accepter toute interférence, y compris les interférences pouvant entraîner un fonctionnement indésirable de l'appareil.

Anatel Warning

Este equipamento não tem direito à proteção contra interferência prejudicial e não pode causar interferência em sistemas devidamente autorizados.

Declaration of Conformity

Hereby, Garmin declares that this product is in compliance with the Directive 2014/53/EU. The full text of the EU declaration of conformity is available at the following internet address: www.garmin.com/compliance.

Radio frequency/protocol: Bluetooth® wireless technology 2.4 GHz @ -0.49 dBm nominal



SOFTWARE LICENSE AGREEMENT

BY USING THE DEVICE, COMPONENT OR SYSTEM MANUFACTURED OR SOLD BY GARMIN ("THE GARMIN PRODUCT"), YOU AGREE TO BE BOUND BY THE TERMS AND CONDITIONS OF THE FOLLOWING SOFTWARE LICENSE AGREEMENT. PLEASE READ THIS AGREEMENT CAREFULLY. Garmin Ltd. and its subsidiaries ("Garmin") grants you a limited license to use the software embedded in the Garmin Product (the "Software") in binary executable form in the normal operation of the Garmin Product. Title, ownership rights, and intellectual property rights in and to the Software remain with Garmin and/or its third-party providers. You acknowledge that the Software is the property of Garmin and/or its third-party providers and is protected under the United States of America copyright laws and international copyright treaties. You further acknowledge that the structure, organization, and code of the Software are valuable trade secrets of Garmin and/or its third-party providers and that the Software in source code form remains a valuable trade secret of Garmin and/or its third-party providers. You agree not to reproduce, decompile, disassemble, modify, reverse assemble, reverse engineer, or reduce to human readable form the Software or any part thereof or create any derivative works based on the Software. You agree not to export or re-export the Software to any country in violation of the export control laws of the United States of America.

Part Number	Change Summary
190-01878-01	Initial release

Rev	Date	Description
A	July, 2016	Production Release
B	September, 2017	Updated compliance statements
C	February, 2018	Added ANATEL regulation, SLA, reference to GMA 345 3-COM, and updated labeling error.

Power-Up	10
Mono/Stereo Headsets	10
Left/Right Knobs	10
Transceivers	11
Split-COM Mode	12
Transmit Indications	12
Enabling/Disabling Monitored COM Muting	12
Receivers	14
Nav Receiver	14
Auxiliary Inputs	14
Marker Beacon Receiver	15
Turning Marker Beacon Audio On	16
Muting Marker Beacon Audio	16
Deselecting Marker Beacon Audio	16
Intercom System (ICS)	16
Pilot Isolate Mode	17
Crew Isolate Mode	17
Intercom Volume	17
Radio Mute Music	17
ICS Mute Music	18
Passenger Muting	18
Speaker	18
Passenger Address Mode (PA Mode)	18
Split-PA Mode	19
3D Audio	19
Enabling 3D Audio	19
Clearance Recorder and Player	22
Entertainment Inputs	23
Music Effects	25
Entertainment Muting	25
Enabling/Disabling Muting	25
Bluetooth®	25
Pairing a Bluetooth Device	26
Pairing to a Garmin VIRB X or VIRB XE Action Camera	27
Pairing To A Third-Party Camera	27
Disabling Bluetooth	28
Bluetooth Media Controls	28
Bluetooth Telephone Volume Controls	28
USB Power Jack	29
Fail-Safe Operation	29

FEATURES AND OPERATION

The GMA 345 Audio Panel provides the traditional audio selector functions of microphone and receiver audio selection. The Audio Panel includes an intercom system (ICS), a marker beacon receiver, a COM clearance recorder, USB power jack, and Bluetooth® audio. Ambient noise from the aircraft radios is reduced by Avionics Squelch (ASQ). When no audio is detected, ASQ processing further reduces the amount of background noise. Intercom squelch threshold adjustments are handled automatically by the system.

Pushbutton keys control audio selection. When a key is selected, a green annunciator on the key is illuminated. Annunciator brightness is adjusted automatically by photocell dimming. Key brightness is adjusted by the radio dimming bus control. Three Aux inputs are available for additional avionics or audio devices.

Upon installation, the unit may be configured in various ways depending on aircraft type and the needs of the pilot.



GMA 345



NOTE: The 3-COM version of the GMA 345 (below) is described in the GMA 345 3-COM Pilot's Guide (Part Number: 190-01878-05).



GMA 345 (3-COM) User Interface

POWER-UP

The GMA 345 performs a self-test during power-up. During the self-test all Audio Panel annunciator lights illuminate for approximately two seconds. Once the self-test is completed, most of the settings are restored to those in use before the unit was last turned off.

MONO/STEREO HEADSETS

Stereo headsets are recommended when using the GMA 345. Using a monaural headset in a stereo jack shorts the right headset channel output to ground. While this does not damage the Audio Panel, a person listening on a monaural headset hears only the left channel in both ears. If a monaural headset is used at one of the passenger positions, any other passenger using a stereo headset hears audio in the left ear only.

LEFT/RIGHT KNOBS

The **Left Inner Knob** powers-off the unit, and is used to control pilot ICS volume. The **Left Outer Knob** controls pilot music volume. The **Right Inner Knob** controls copilot and passenger ICS volume. The **Right Outer Knob** controls the copilot and passenger music volume.

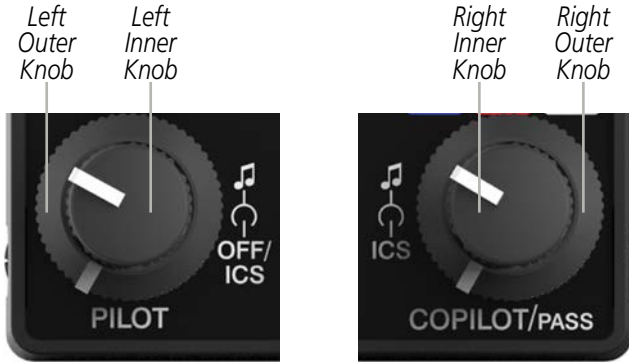

Left Knob - Pilot Volume Controls

Right Knob - Copilot and Passenger Volume Controls

Function	Action	Visual/Tactile Feedback	Aural Feedback
Power OFF Audio Panel	Turn Left Inner Knob to full counter-clockwise position	All backlight and annunciator LEDs turn off	Left Inner Knob clicks
Pilot ICS Volume	Turn Left Inner Knob right/left to increase/decrease volume	Minimum/maximum volume is reached at full counter-clockwise/clockwise position	Pilot ICS volume increases/decreases
Pilot Music Volume	Turn Left Outer Knob right/left to increase/decrease volume	Minimum/maximum volume is reached at full counter-clockwise/clockwise position	Pilot Music volume increases/decreases
Copilot/Passenger ICS Volume	Turn Right Inner Knob right/left to increase/decrease volume	Minimum/maximum volume is reached at full counter-clockwise/clockwise position	Copilot and Passenger ICS volume increases/decreases
Copilot/Passenger Music Volume	Turn Right Outer Knob right/left to increase/decrease volume	Minimum/maximum volume is reached at full counter-clockwise/clockwise position	Copilot and Passenger Music Volume increases/decreases

Left/Right Knob Functions

TRANSCIVERS

Audio from the #1 or #2 COM receiver can be selected independently by pressing the respective Key(s) (**COM1** or **COM2**). Pressing **COM1 MIC** or **COM2 MIC** selects the #1 or #2 transmitter and simultaneously selects the related COM receiver (COM1 or COM2) allowing received audio to be heard. The other COM receiver can be added by pressing the respective key.

By default, while transmitting on a COM channel (as selected with the **COM1 MIC** and **COM2 MIC** keys), both the transmitting and receiving audio are heard on the COM channel. The GMA 345 can be configured to instead mute receiving audio on a transmitting COM channel. A Garmin authorized service center can make changes to the default configuration.

SPLIT-COM MODE



NOTE: *Split COM performance is affected by the distance between the COM antennas and the separation of the tuned frequencies. If the selected COM frequencies are too close together, interference may be heard during transmission on the other radio.*

During Split-COM operation, both the pilot and the copilot can transmit simultaneously over separate radios. The pilot uses COM1 and the copilot uses COM2

Pressing both **MIC** Keys simultaneously initiates Split-COM Mode (i.e., COM1/COM2). The respective COM1/COM1 MIC and COM2/COM2 MIC annunciators are illuminated indicating Split-COM operation. Split-COM operation is cancelled by pressing one of the selected MIC Keys again.





TRANSMIT INDICATIONS

During COM transmission, the active transceiver (MIC1 or MIC2) Key Annunciator flashes approximately once per second.

During Split-COM transmission, the MIC1 annunciator flashes when the pilot’s microphone PTT is pressed. The MIC2 annunciator flashes when the copilot’s microphone PTT is pressed.

ENABLING/DISABLING MONITORED COM MUTING

Press and hold **COM1** or **COM2** to enable/disable monitored COM muting during reception of audio from the COM radio selected for transmission. The aural message “**Monitor Mute Enabled/Disabled**” is heard.

Function	Action	Key Annunciations	
<p>COM Selection: Toggle between COM enabled and COM disabled (the audio from the current MIC selected COM is always enabled and cannot be disabled).</p>	<p>Press the corresponding COM Key.</p>	 COM Enabled	 COM Disabled
<p>MIC Selection: Selects the COM used to transmit during Push-to-Talk (PTT).</p>	<p>Press the corresponding MIC Key. The last MIC pressed remains selected and deselects all others.</p>	 MIC Enabled	 MIC Disabled
<p>Transmit Indication: Audio is sent from the corresponding Crew MIC to the selected COM. *</p>	<p>Push-to-Talk (PTT) keyed.</p>		<p>MIC in-key annunciator flashes.</p>

Function	Action	Key Annunciations
<p>Split-COM Mode: The pilot transmits on COM1 and the copilot transmits on COM2 independently.</p>	<p>Simultaneously press COM1 MIC and COM2 MIC keys.</p>	
<p>* The pilot has priority when transmitting in the case that both crew members attempt to transmit on the same COM.</p>		

Transceiver Key Functions

RECEIVERS

NAV RECEIVER

Pressing the **NAV1** and/or **NAV2** Key(s) selects/deselects the receiver audio for the corresponding navigation radio source. The selected audio source can be heard over the headset and the speaker (if selected). All radios can be selected individually or simultaneously.



Selecting a NAV Radio Receiver

AUXILIARY INPUTS

The GMA 345 has 3 AUX inputs. There are two keys on the unit for **AUX1** and **AUX2**. Pressing the **AUX1** key selects or deselects both the AUX1 and AUX3 receivers. Pressing the **AUX2** key selects or deselects only the AUX2 receiver.



Selecting an Auxiliary Input

MARKER BEACON RECEIVER

The marker beacon receiver detects any marker beacon signal within the reception range of the aircraft.

When a marker beacon signal is detected, the lamps illuminate, and an associated keyed-tone is heard when MKR audio is selected. Marker beacon lamps operate independently of any audio selection and cannot be turned off.

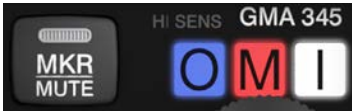

Marker Beacon Key & Lamps

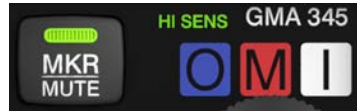

HI SENS Annunciator

The marker beacon signal sensitivity threshold can be set to either a regular or high sensitivity. To toggle between the two, press and hold the **MKR/MUTE** Key for one second. The HI SENS annunciator illuminates when signal sensitivity is set to high.

The receiver detects the three marker tones (outer, middle, and inner).

Audio Frequency	Audio Keying	Lamp Actuated
400 Hz (Outer)	— — — — —	Blue
1300 Hz (Middle)	· — — · — — · — — · — —	Amber
3000 Hz (Inner)	· · · · ·	White

The GMA 345 provides three states of marker beacon operation; On, Muted, and Deselected. The **MKR/MUTE** key annunciator indicates when marker beacon audio is selected. Marker beacon audio is not heard when the annunciator is off or when the annunciator is on with the marker beacon audio muted.

TURNING MARKER BEACON AUDIO ON

With the MKR/MUTE annunciator off, press the **MKR/MUTE** Key to activate marker beacon audio and illuminate the MKR/MUTE annunciator.

MUTING MARKER BEACON AUDIO

During marker beacon audio reception, press the **MKR/MUTE** Key to mute the audio. The MKR/MUTE annunciator remains lit, but the current marker tone is silenced. Audio muting deactivates automatically and marker beacon audio is heard when the next marker beacon signal is received.

DESELECTING MARKER BEACON AUDIO

To deselect marker beacon audio, press the **MKR/MUTE** Key twice during marker beacon reception or once if a marker beacon signal is not detected.

INTERCOM SYSTEM (ICS)

The GMA 345 includes a three-position intercom system (ICS), two MUSIC inputs, and one telephone/entertainment input for the pilot, copilot and passengers. The intercom provides Pilot and Crew audio isolation.



Intercom Controls



NOTE: The **PILOT** and **CREW** ICS ISOLATION states are exclusive. Both cannot be active at the same time. When neither Pilot or Crew are active, the unit is in All ICS mode. In this mode, the pilot, copilot, and passengers communicate with each other.

PILOT ISOLATE MODE

Pressing the **PILOT** 'ICS ISOLATION' Key isolates the pilot from all other ICS positions (copilot and passengers). The copilot and passengers share communication between themselves but cannot communicate with the pilot. A solid annunciation of the in-key annunciator indicates PILOT ICS ISOLATION is active.

CREW ISOLATE MODE

Pressing the **CREW** 'ICS ISOLATION' Key places the pilot and copilot on a common ICS communication channel. The passengers are on their own intercom channel and can communicate with each other, but cannot communicate with the pilot and copilot. A solid annunciation of the inkey annunciator indicates CREW ICS ISOLATION is active.

INTERCOM VOLUME

The knobs on either side of the GMA 345 control intercom and music volume independently. The left inner and outer knobs are dedicated to the audio levels for the pilot headset; the right inner and outer knobs control audio levels for not only the copilot but also any passenger headsets. The inner, smaller knobs on both sides are used to control intercom volume for the receiving headsets. The outer, larger knobs are used to control music volume.

The left inner knob can be used to turn off the GMA 345 audio panel, by turning fully counter-clockwise until the knob clicks. All backlight and annunciator LEDs will turn off.

The position marks on all four knobs are not night-time visible.

RADIO MUTE MUSIC

Press and hold the **MUSIC** Key to enable or disable muting of music channel 1, music channel 2 and Bluetooth music audio when radio (i.e., COM, NAV, or AUX) audio is active.

ICS MUTE MUSIC

Press and hold the **AUX2** Key to enable or disable muting of music audio when intercom audio is active.

PASSENGER MUTING

Press and hold **AUX1** to enable/disable passenger muting during COM audio reception. The aural message “Passenger Mute Enabled/Disabled” is heard.

SPEAKER



NOTE: *Speaker audio turns off in circumstances where aircraft power falls below 11 volts.*

All of the radios can be heard over the cabin speaker. Pressing the **SPKR** Key selects and deselects the cabin speaker. Speaker audio is muted when the PTT is pressed. Certain aural alerts and warnings (autopilot, traffic, altitude) are always heard on the speaker, even when the speaker is not selected.



Speaker Key

PASSENGER ADDRESS MODE (PA MODE)

Press and hold the **SPKR** Key for one second to initiate Passenger Address Mode. PA Mode is annunciated by a rapid blinking of the SPKR annunciator. When in PA Mode the crew can use the PTT “Push-to-Talk” button to deliver announcements over the speaker and to the passenger headsets.

SPLIT-PA MODE

During Split-PA Mode the pilot can continue to use COM1 for transmission while the copilot delivers PA announcements. To initiate Split-PA Mode, first enter Split-COM Mode by pressing both **MIC** Keys simultaneously, then press and hold the **SPKR** Key for one second.

3D AUDIO

3D Audio is useful when multiple audio sources are present. By using different responses in each ear, 3D audio processing creates the illusion that each audio source is coming from a unique location or seat position.

Because this feature uses different signals for left and right channels, it requires wiring for stereo intercom and stereo headsets. If 3D audio is activated when mono headsets are in use, the listener will still hear all audio sources; however, there is no benefit from location separation.

With a single COM selected and 3D Audio enabled, the listener hears the audio source at the 12 o'clock position. If both COMs are selected, the listener hears COM1 at 11 o'clock and COM2 at the 1 o'clock position. All other intercom positions are processed to sound like their relative seat location. By default, the GMA 345 assumes the pilot sits in the left seat. A Garmin authorized service center can make changes to the default configuration.

ENABLING 3D AUDIO

Press and hold the **PILOT** Key to toggle 3D audio processing on and off for all headset positions. When 3D Audio is enabled, the aural message "3D audio left" is heard in the left ear followed by "3D audio right" in the right ear. If the aural messages are not heard in only the left and then the right ear respectively, the cause may be aircraft wiring or headset settings. Refer to the following table if a headset or aircraft wiring problem is suspected.

3D Audio Troubleshooting		
Symptom(s)	Cause(s)	Solution(s)
"3D audio left" message heard in both ears. "3D audio right" message not heard	1) Mono headset in use	1) Use a stereo headset
	2) Stereo headset in use with mono/stereo switch set to 'mono'	2) Set mono/stereo switch on headset to 'stereo'
	3) Aircraft wiring has left audio wired to both left and right channels of stereo headset jack	3) If after checking solutions #1 and #2 see a service center as soon as possible to inspect/correct wiring. This wiring fault can cause fail-safe audio not to function.

3D Audio Troubleshooting		
<p>"3D audio left" message heard in both ears, followed by "3D audio right" message heard in both ears</p>	<p>1) Mono headset in use</p>	<p>1) Use a stereo headset</p>
	<p>2) Stereo headset in use with mono/stereo switch set to mono</p>	<p>2) Set mono/stereo switch on headset to 'stereo'</p>
	<p>3) Incorrect aircraft wiring (left/right shorted together)</p>	<p>3) If after checking solutions #1 and #2 see a service center as soon as possible to inspect/correct wiring. This wiring fault can cause fail-safe audio not to function.</p>
<p>"3D audio right" message heard in both ears. "3D audio left" not heard</p>	<p>1) Incorrect aircraft wiring (right channel used for mono instead of left or left/right swapped)</p>	<p>1) See a service center as soon as possible to inspect/correct wiring. This wiring fault can cause fail-safe audio not to function.</p>
<p>"3D audio left" message heard in right ear only followed by "3D audio right" message heard in left ear only</p>	<p>1) Stereo headset is on backwards</p>	<p>1) Verify correct orientation from the left/right indication on each side of the headset or the position of the boom MIC (usually attached on left side). If the headset is backwards, the left/right position information will be swapped.</p>
	<p>2) Incorrect aircraft wiring (left/right channels swapped)</p>	<p>2) See a service center as soon as possible to inspect/correct wiring. This wiring fault can cause fail-safe audio not to function.</p>
<p>"3D audio left" message heard in left ear only, no audio heard in right ear.</p>	<p>1) Aircraft wired for mono intercom</p>	<p>1) See a service center to wire the installation for stereo headsets.</p>

3D Audio Troubleshooting		
"3D audio right" message heard in right ear only, no audio heard in left ear	1) Incorrect aircraft wiring (right channel used for mono instead of left, or left/right swapped)	1) See a service center as soon as possible to inspect/correct wiring. This wiring fault can cause fail-safe audio not to function.

3D Audio Troubleshooting

CLEARANCE RECORDER AND PLAYER

The GMA 345 contains a digital clearance recorder that records up to 60 seconds of the selected COM radio signal. Recorded COM audio is stored in separate memory blocks. Once 60 seconds of recording time have been reached, the recorder begins recording over the stored memory blocks, starting from the oldest block.

Pressing the **PLAY** Key once plays the latest recorded memory block.

Pressing the **MKR/MUTE** Key during play of a memory block stops play. If a COM signal is detected during play of a recorded memory block, play is halted.

Pressing the **PLAY** Key while audio is playing begins playing the previously recorded memory block. Each subsequent press of the **PLAY** Key selects the previously recorded memory block.

Powering off the unit automatically clears all recorded blocks.



Left Knob - Pilot Volume





Marker Mute Key









ENTERTAINMENT INPUTS

The GMA 345 provides four telephone/entertainment inputs:

- Press the **MUSIC** Key to turn music on/off for all positions. The **SEL** Key selects the music source (Music 1, Music 2, or Bluetooth Music) for all positions. The pilot can choose not to hear music by either turning down the Pilot music volume or enabling **PILOT** 'ICS ISOLATION'. The copilot and passengers can choose not to hear music by turning down the Copilot/Passenger music volume. Refer to the following table on **MUSIC** and **SEL** Key Functions for more information.
- Press the **TEL** Key to enable Bluetooth telephone or rear connector wired telephone connection to ICS. When a Bluetooth telephone connection is active the rear telephone connection is disabled. Distribution is controlled by ICS isolation state. When the **TEL** Key is selected, the pilot is always connected to the telephone interface. Other ICS positions are connected to the telephone interface if they hear the Pilot in that ICS state.

Function	Action	Key Annunciations	Notes
Turn MUSIC ON	Press the MUSIC Key (when not selected).		MUSIC in-key annunciator turns green.
Turn MUSIC OFF	Press the MUSIC Key (when selected).		MUSIC in-key annunciator turns OFF (source selection annunciators are unaffected).
Change MUSIC Source	Press the SEL Key.		Music source selection is cyclic, moving from 1 to 2 to 3 and then back to 1 .

MUSIC and SEL Key Functions

Function	Action	Key Annunciations	
Toggle TEL Audio ON/OFF	Press the TEL Key.		TEL in-key annunciator toggles between green and OFF.
Receive Bluetooth Phone Call	Incoming call. *		TEL flashes blue indicating an incoming Bluetooth phone call.
Answer Bluetooth Phone Call	Press TEL during incoming call (TEL flashing).		TEL displays solid blue.
Bluetooth Phone Call Disconnected By Source	Lost connection or user action.	 or 	TEL returns to previous state (green or OFF).
Disconnect Bluetooth Phone Call Using GMA 345	Press TEL .	 or 	TEL returns to previous state (green or OFF).
Bluetooth Phone Call Initiated by Source/Phone	Press TEL , if TEL is not yet selected.		TEL displays solid blue.
* If TEL is selected (green), pre-recorded ringer audio is played.			
** If TEL is selected (green), no action is required. TEL automatically turns blue and connects.			

TEL Key Functions

MUSIC EFFECTS

The following music effects are available:

- **Music Equalizer:** Press the **SEL** Key and the **PILOT** Key simultaneously to change the selected Music Equalizer setting. Available settings include: Disabled, Classical, Pop, or Rock.
- **Music Bass Boost:** Press the **SEL** Key and the **CREW** Key simultaneously to change the selected Music Bass Boost setting. Available settings include: Disabled, Medium, or High.

ENTERTAINMENT MUTING

Entertainment muting can be enabled or disabled by the user, however it is always muted during alerts.

ENABLING/DISABLING MUTING

Press and hold the **MUSIC** Key for 1 second to toggle radio muting of music on and off. The aural message “**Radio Mute Music Enabled/Disabled**” is heard.

Press and hold the **AUX2** button for one second to toggle intercom muting of music on and off. The aural message “**Intercom Mute Music Enabled/Disabled**” is heard.

BLUETOOTH®

The GMA 345 supports the following Bluetooth profiles and functions:

- A2DP Bluetooth profile for entertainment audio input.
- HFP Bluetooth profile for connection to a telephone (alternate interface for wired TEL function).
- Ability to deliver Bluetooth audio to a VIRB X or VIRB XE Action Camera via HFP 1.6 “Wide Band Speech” format.
- Ability to deliver Bluetooth audio to third-party cameras that are capable of receiving audio via the Hands-Free Profile. HFP 1.6 “Wide Band Speech” format is supported by the GMA 345.
- AVCRP Bluetooth profile for entertainment audio media controls (Play/Pause, Skip Forward, and Skip Previous).

During power up the GMA automatically reconnects to the last connected device. This is annunciated by the Bluetooth annunciator illuminating.

If the same Bluetooth device is used to play music and make a phone call, the phone has priority and the music audio is suspended. Music audio resumes when the phone call disconnects and the music connection is re-established by the source device.

PAIRING A BLUETOOTH DEVICE



NOTE: *The Bluetooth annunciation is illuminated only when a Bluetooth device is connected.*

Pairing mode allows a new device to discover and create a connection to the GMA 345. Additionally, pairing mode is used to forcefully disconnect a device currently connected to the GMA 345.

Press and hold the **TEL (PAIR)** Key for one second to enter pairing mode. The Bluetooth annunciator flashes to indicate the GMA 345 is in pairing mode and “Pairing Enabled” audio is played. Once the Bluetooth annunciator flashes, the GMA is discoverable for two minutes, or until a device is paired or connected. While discoverable, a Bluetooth enabled device (e.g., cellphone or tablet) can find and pair with the GMA. Refer to the device’s instruction manual for information on how to pair and connect to a new Bluetooth device. Once paired and connected, the Bluetooth annunciator on the GMA stops flashing and remains lit as long as the Bluetooth connection is active. The GMA remembers the last 10 paired devices. When the paired devices list is full and a new device is paired, the least recently connected device is removed from the paired device list.

PAIRING TO A GARMIN VIRB X OR VIRB XE ACTION CAMERA



NOTE: *The GMA 345 is capable of connecting to one Bluetooth device at a time.*

The GMA 345 supports Bluetooth wireless delivery of pilot headphone audio to versions of the Garmin VIRB action camera that support Bluetooth mic audio input for recording.

Pairing a Garmin VIRB to the GMA 345 works like pairing other Bluetooth audio devices. Once connected, pilot headphone audio will be delivered to the VIRB via Bluetooth. In a connection to the Garmin VIRB, the GMA is the source. Therefore, selecting an entertainment key is not required.

PAIRING TO A THIRD-PARTY CAMERA



NOTE: *The third party camera must support receiving audio via the Bluetooth Hands-Free Profile.*



NOTE: *The third party camera must initiate the initial pairing process with the GMA 345.*

Press and hold the **TEL (PAIR)** Key for one second to put the GMA 345 into pairing mode. Reference the third party camera's manual for its pairing instructions. Once the pairing process is complete the GMA 345 and the third party camera will connect to each other via the Hands Free Profile. During this initial connection, Bluetooth Recording Mode will need to be enabled on the GMA 345 for the third party camera. To enable Bluetooth Recording Mode momentarily press the **TEL (PAIR)** and **PILOT** keys simultaneously. When this feature is enabled, the "Bluetooth Recording Mode Enabled" message is played on the intercom. Enabling Bluetooth Recording Mode only needs to be done once. When the GMA 345 and the third party camera connect again in the future Bluetooth Recording Modes will automatically be enabled.

DISABLING BLUETOOTH

To aid in troubleshooting, the GMA 345 Bluetooth can be disabled. To disable, press and hold the **TEL (PAIR)** Key for five seconds. “Bluetooth Disabled” audio is played. To re-enable without powercycling, press and hold the **TEL (PAIR)** Key for five seconds. “Bluetooth Enabled” audio is played.

Note that Bluetooth will always be enabled when the GMA 345 is powercycled.

BLUETOOTH MEDIA CONTROLS

With a Bluetooth device connected, music enabled, and the Bluetooth Music Source selected:

- Press the **NAV2** and **MUSIC** Keys simultaneously to PLAY/PAUSE Bluetooth media.
- Press the **NAV2** and **AUX1** Keys simultaneously to skip to the previous Bluetooth media track.
- Press the **NAV2** and **AUX2** Keys simultaneously to skip to the next Bluetooth media track.

BLUETOOTH TELEPHONE VOLUME CONTROLS

When a Bluetooth telephone call is active and **TEL** is enabled:

- Press and hold the **PILOT** Key to increase the Bluetooth telephone call volume.
- Press and hold the **CREW** Key to decrease the Bluetooth telephone call volume.

USB POWER JACK

The USB power jack is a dedicated charge port and uses a USB Type A jack. The USB power jack will charge any device while the GMA is powered on. In circumstances where the aircraft power falls below 11 volts, the USB power jack will turn off. When the GMA is turned off, the USB power port is also off. The USB power jack supports a maximum of 2.1 Amps charge current to devices.

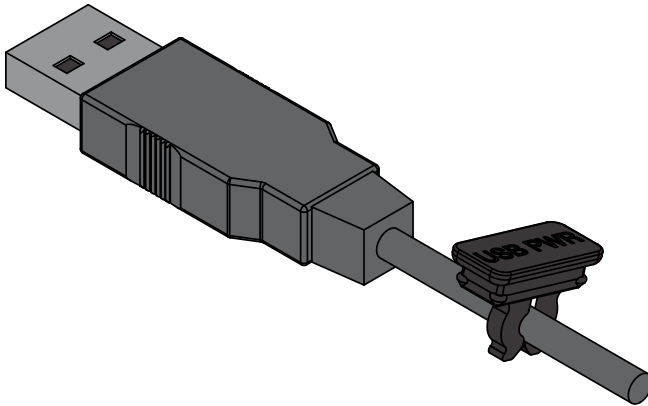

















USB Jack Dust Cover

Note that the GMA USB dust cover can be clipped to any USB cable plugged into the GMA. The dust cover has a clip feature that can attach to a USB cable for temporary storage to prevent losing the cover.

FAIL-SAFE OPERATION

If there is a failure of the GMA 345 or when power is not applied, a fail-safe circuit connects the pilot's headset and microphone directly to the COM1 transceiver. Audio is not available on the speaker during Fail-safe operation.

<p>Monitor Mute</p>	 <p>Press and hold for 1 second</p>	<p>Bluetooth Media Play/Pause</p>	 <p>Press keys simultaneously</p>
<p>Radio Mute Music</p>	 <p>Press and hold for 1 second</p>	<p>Bluetooth Media Skip Previous</p>	 <p>Press keys simultaneously</p>
<p>Passenger Mute</p>	 <p>Press and hold for 1 second</p>	<p>Bluetooth Media Skip Next</p>	 <p>Press keys simultaneously</p>
<p>Intercom Mute Music</p>	 <p>Press and hold for 1 second</p>	<p>BT Call Volume Increase</p>	 <p>Press and hold</p>
<p>3D Audio</p>	 <p>Press and hold for 1 second</p>	<p>BT Call Volume Decrease</p>	 <p>Press and hold</p>
<p>Passenger Address</p>	 <p>Press and hold for 1 second</p>	<p>Bluetooth Pairing Mode</p>	 <p>Press and hold for 1 second</p>
<p>Split COM</p>	 <p>Press keys simultaneously</p>	<p>Bluetooth Recording Mode</p>	 <p>Press keys simultaneously</p>
<p>Marker Beacon High Sens</p>	 <p>Press and hold for 1 second</p>	<p>Music Equalizer</p>	 <p>Press keys simultaneously</p>
		<p>Music Bass Boost</p>	 <p>Press keys simultaneously</p>

Alternate Key Function Quick Reference



Garmin International, Inc.
1200 East 151st Street
Olathe, Kansas, 66062, U.S.A.

Garmin AT Inc.
2345 Turner Road SE
Salem, OR 97302, U.S.A.

Garmin (Europe) Ltd.
Liberty House, Hounsdown Business Park
Southampton, Hampshire SO40 9LR U.K.

Garmin Corporation
No. 68, Zhangshu 2nd Road
Xizhi District, New Taipei City, Taiwan

Contact Garmin Product Support at www.flygarmin.com.

For warranty information refer to
<https://fly.garmin.com/fly-garmin/support/warranty-information/>